

THE INFORMATION CONTAINED IN THIS DRAWING IS THE SOLE PROPERTY OF L-COM, INC. ANY REPRODUCTION IN PART OR WHOLE WITHOUT THE WRITTEN PERMISSION OF L-COM, INC. IS PROHIBITED.

REVISIONS			
REV	DESCRIPTION	DATE	APPROVED
A	INITIAL RELEASE	09/05/2022	GUTTADAURO

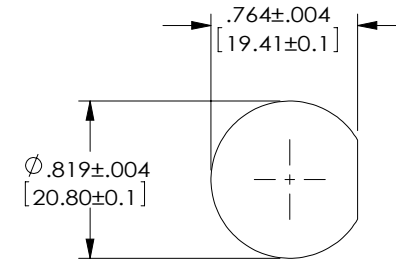
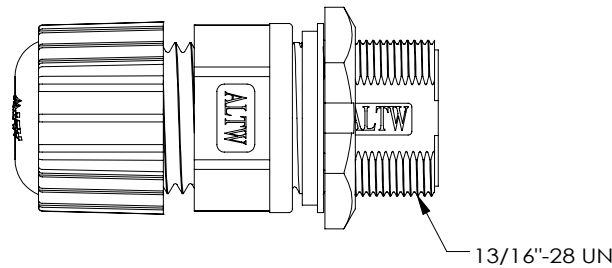
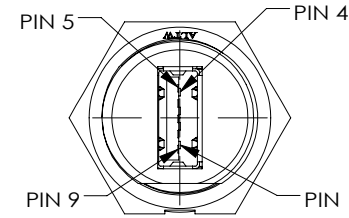
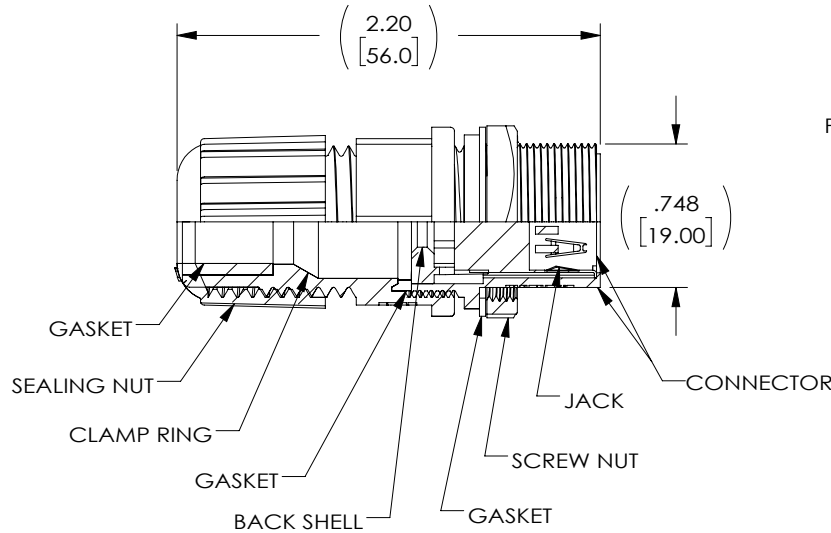
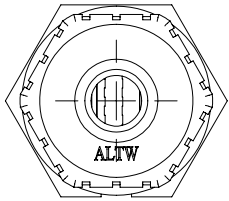

RECOMMENDED
PANEL OPENING

NOTES:

MATERIAL:

CONNECTOR: USB 3.0 A SCREW TYPE, BLACK
 BACK SHELL: NYLON+GF, BLACK
 JACK: PBT, GOLD PLATED
 CLAMP RING: NYLON, BLACK
 SEALING NUT: NYLON, BLACK
 SCREW NUT: NYLON+GF, BLACK
 GASKET: EPDM, BLACK

MISCELLANEOUS:

WATERPROOF RATE: IP67
 SEALS FOR CABLE OD: $\phi 5.0\text{mm} \sim \phi 10.8\text{mm}$
 COMPONENT SHALL BE INDIVIDUALLY PACKAGED IN ACCORDANCE WITH L-COM SPEC. PS-0031.

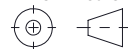
UNLESS OTHERWISE SPECIFIED, DIMENSIONS ARE IN INCHES [mm] OVERALL CABLE LENGTH TOLERANCE: ≤12 [305] = +1 [25] / -0 >12 [305] ≤60 [1524] = +2 [51] / -0 >60 [1524] ≤120 [3048] = +4 [102] / -0 >120 [3048] ≤300 [7620] = +6 [152] / -0 >300 [7620] = +5% / -0 ALL OTHER DIMENSIONAL TOLERANCES: .X = ± .2 [5] FRACTIONS ± 1/32 .XX = ± .02 [.5] ANGLES ± 1° .XXX = ± .005 [.13]	APPROVALS	DATE	 50 High Street, West Mill, North Andover, MA 01845 USA. Phone: 1.800.341.5266 1.978.682.6936
	DRAWN BY SLI	01/26/2022	
APPROVED BY GUTTADAURO	01/26/2022	CATEGORY USB	
CONFIGURATION DETAILS OF UNDIMENSIONED FEATURES MAY VARY	PRODUCT DESCRIPTION CONN, WTR PRF USB 3.0 A-F		
THIRD-ANGLE PROJECTION 	COLOR VARIATIONS MAY OCCUR	SIZE A	CAGE CODE 43321
		DWG. NO. WPUSBCN-A-3	REV. A
		SCALE: NONE	CAD FILE: WPUSBCN-A-3.SLDDRW
		SHEET 1 OF 1	