

6

5

4

3

2

1

F

F

E

E

D

D

C

C

B

B

A

A

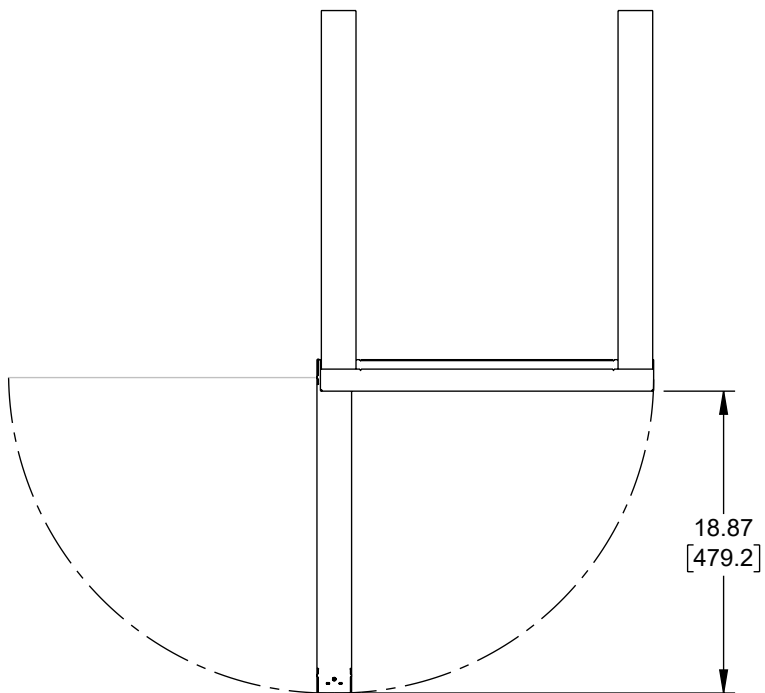

TOP VIEW 1

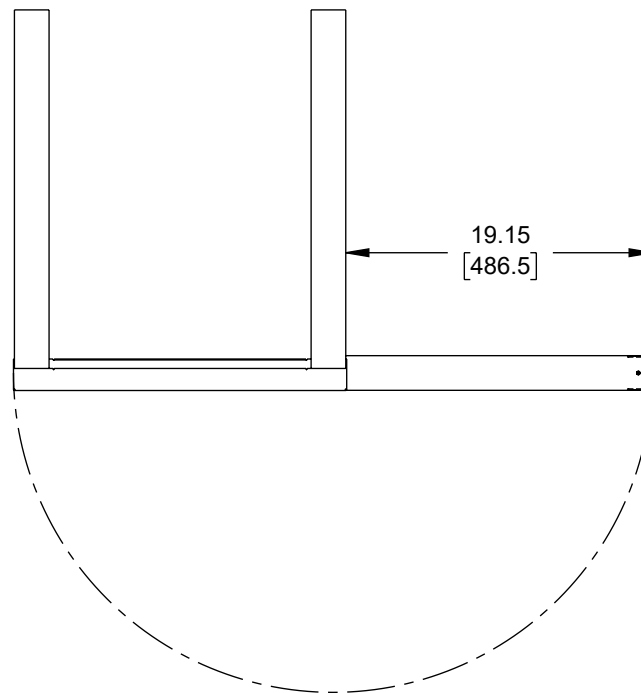

TOP VIEW 2

THE INFORMATION CONTAINED IN THIS DRAWING IS THE SOLE PROPERTY OF INFINITE ELECTRONICS, INC. ANY REPRODUCTION IN PART OR WHOLE WITHOUT THE WRITTEN PERMISSION OF INFINITE ELECTRONICS, INC. IS PROHIBITED. THESE COMMODITIES, TECHNOLOGY OR SOFTWARE WERE EXPORTED FROM THE UNITED STATES IN ACCORDANCE WITH THE EXPORT ADMINISTRATION REGULATIONS. DIVERSION CONTRARY TO U.S. LAW PROHIBITED.

ALL DIMENSIONS ARE FOR REFERENCE ONLY AND SUBJECT TO CHANGE WITHOUT NOTICE. UN-DIMENSIONED/NON-CRITICAL FEATURES MAY VARY IN SIZE AND LOCATION. COLORS MAY VARY.

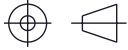
 Show Me CABLES an INFINIT® brand Website: www.ShowMeCables.com Phone: 1.888.519.9505		 INTERPRET ALL DIMENSIONS AND TOLERANCES PER ASME Y14.5	
		SCALE NONE	SHEET 2 OF 2
DESCRIPTION 9U SWING GATE WALL RACK (24" DEPTH)			
SIZE A	CAGE CODE 3SVT8	DRAWN BY DMAY	ITEM NO. SMC-24INSGWR-9U
			REV A

6

5

4

3

2

1