

REVISIONS			
REV.	DESCRIPTION	DATE	APPROVED
A	INITIAL RELEASE	05/05/2022	PHOSPODAR

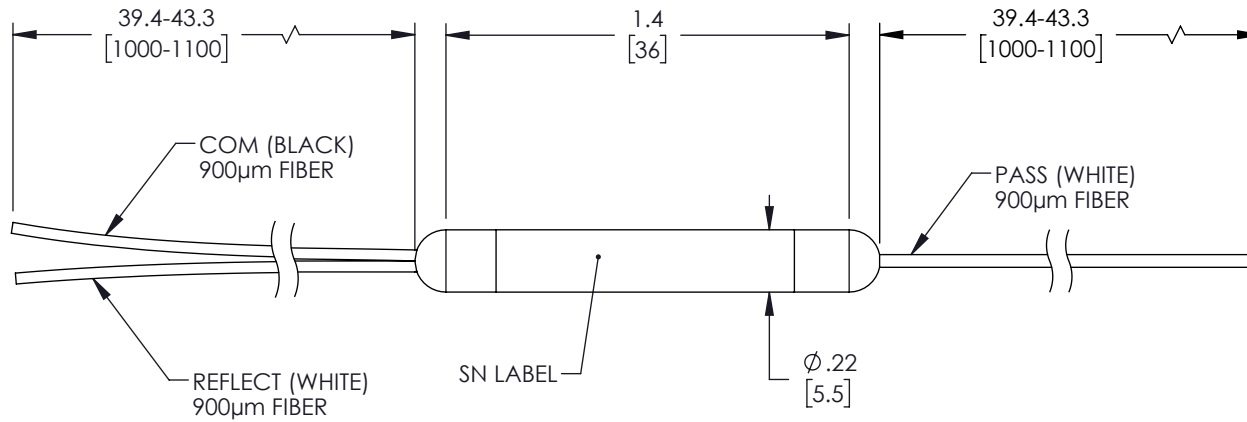

UNLESS OTHERWISE SPECIFIED
LEADING DIMENSIONS ARE INCHES
DIMENSIONS IN [] ARE MILLIMETERS

TOLERANCES:

X = ± .2	[5.08]	FRACTIONS
.XX = ± .02	[.51]	± 1/32
XXX = ± .005	[-.13]	ANGLES ± 1°

CABLE LENGTH (L) TOLERANCES:

L ≤ 12	[305]	= +1 [25] / -0
12 [305] < L ≤ 60	[1524]	= +2 [51] / -0
60 [1524] < L ≤ 120	[3048]	= +4 [102] / -0
120 [3048] < L ≤ 300	[7620]	= +6 [152] / -0
300 [7620] < L		= +5%L / -0

ALL DIMENSIONS SHOWN
ARE FOR REFERENCE ONLY.



50 High Street, West Mill, 3rd Floor, Suite #30
North Andover, MA 01845 USA.
Phone: 1.800.341.5266 | 1.978.682.6936
Fax: 1.978.689.9484
Website: www.L-com.com
E-mail: CustomerService@L-com.com

THIRD-ANGLE PROJECTION

THE INFORMATION AND
DESIGN IN THIS DOCUMENT
IS THE PROPERTY OF
L-COM GLOBAL CONNECTIVITY.
ALL RIGHTS RESERVED.

SHEET 1 OF 1

SCALE N/A

SIZE	CAGE CODE	DRAWN BY	ITEM NO.	REV
A	43321	KGLEBOVA	PDW5A-01152-19NN	A

THESE COMMODITIES, TECHNOLOGY OR SOFTWARE WERE EXPORTED FROM THE UNITED STATES IN ACCORDANCE WITH THE EXPORT ADMINISTRATION REGULATIONS. DIVERSION CONTRARY TO U.S. LAW PROHIBITED.