

THE INFORMATION CONTAINED IN THIS DRAWING IS THE SOLE PROPERTY OF L-COM, INC. ANY REPRODUCTION IN PART OR WHOLE WITHOUT THE WRITTEN PERMISSION OF L-COM, INC. IS PROHIBITED.

REVISIONS			
REV	DESCRIPTION	DATE	APPROVED
A	INITIAL RELEASE	11/06/2019	MMARTINEZ
B	ECN 10369: ADDED "ALL DIMENSIONS FOR REFERENCE ONLY"	02/13/2020	MMARTINEZ

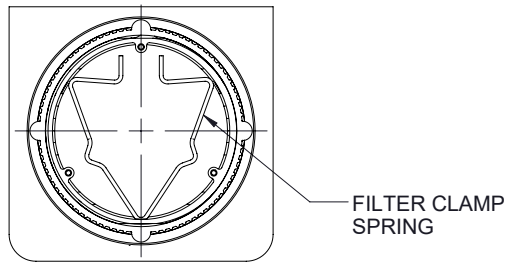
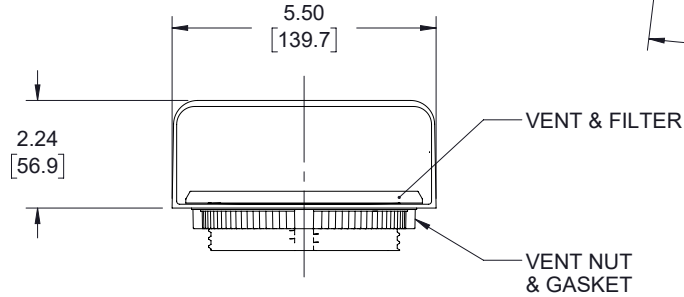
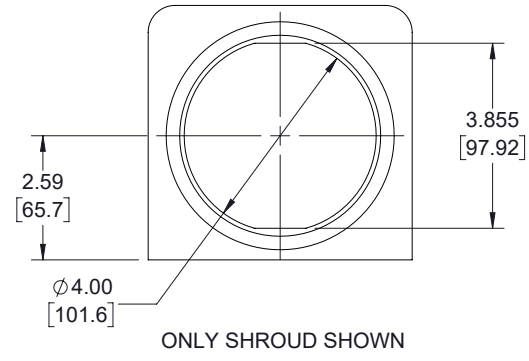
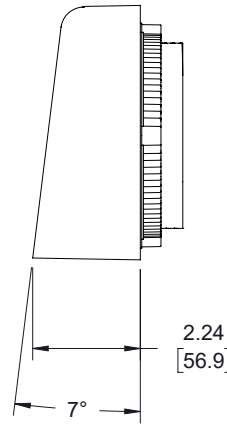
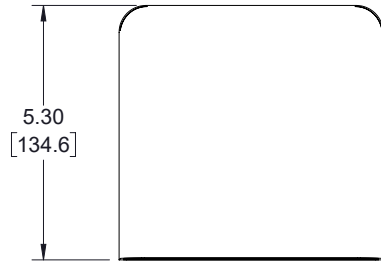

**SHROUD MATERIAL:  
POLYCARBONATE (DARK GRAY)**

**ALL DIMENSIONS FOR REFERENCE ONLY**

**KIT CONTAINS 1:  
SHROUD, VENT, FILTER, GASKET, & VENT NUT**

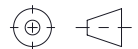
UNLESS OTHERWISE SPECIFIED, DIMENSIONS ARE IN INCHES [mm]  DIMENSIONAL TOLERANCES: .X = ± .1 [2.54]      FRACTIONS ± 1/32 .XX = ± .01 [25]      ANGLES ± 1° .XXX = ± .005 [13]	APPROVALS DRAWN BY DZINN	DATE 11/06/2019	 an INFINITO brand	50 High Street, West Mill, North Andover, MA 01845 USA. Phone: 1.800.341.5266 1.978.682.6936
	CHECKED BY DFRISIELLO	11/06/2019		CATEGORY ENCLOSURE
THIRD-ANGLE PROJECTION 	APPROVED BY MMARTINEZ	11/06/2019	PRODUCT DESCRIPTION Fan Shroud Vent Filter Kit Gray - one pc	
COLOR VARIATIONS MAY OCCUR	SIZE <b>A</b>	CAGE CODE <b>43321</b>	DWG. NO. NBPC-FV1	REV. <b>B</b>
SCALE: NONE		CAD FILE: NBPC-FV1.SLDDRW		SHEET 1 OF 1