

6 5 4 3 2 1

REVISION					
ZONE	REV.	DESCRIPTION	DATE	CHANGED BY	APPROVED BY
	A	INITIAL RELEASE	12/12/2022	PSRINIVAS	KHIETPAS

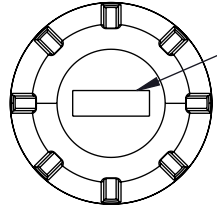

LABEL PER ILS-100-05  
(SEE NOTE 1)

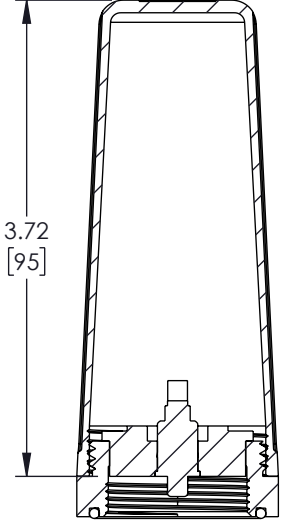
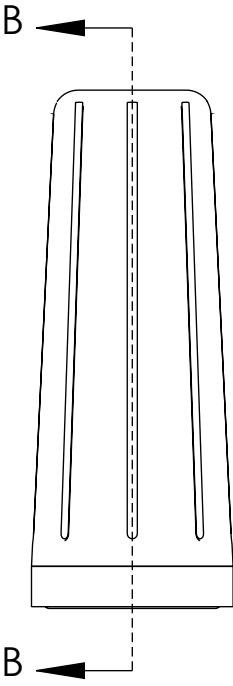
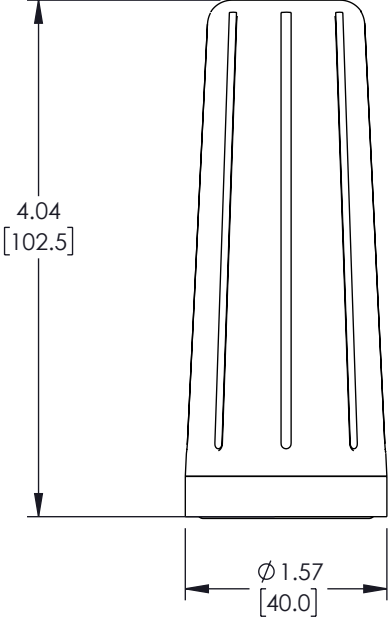

SECTION B-B

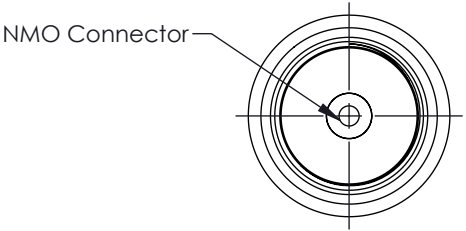
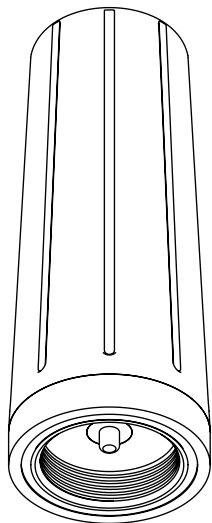

NMO Connector

NOTES:

1. LABEL PER ILS-100-05 (FOR INTERNAL USE ONLY).  
LABEL LOCATION SHOWN IS FOR REFERENCE ONLY.

REGULATORY COMPLIANCE:

EU RoHS DIRECTIVE (MOST RECENT RELEASED VERSION)

THE INFORMATION CONTAINED IN THIS DRAWING IS THE SOLE PROPERTY OF INFINITE ELECTRONICS, INC. ANY REPRODUCTION IN PART OR WHOLE WITHOUT THE WRITTEN PERMISSION OF INFINITE ELECTRONICS, INC. IS PROHIBITED. THESE COMMODITIES, TECHNOLOGY OR SOFTWARE WERE EXPORTED FROM THE UNITED STATES IN ACCORDANCE WITH THE EXPORT ADMINISTRATION REGULATIONS. DIVERSION CONTRARY TO U.S. LAW PROHIBITED.

UNLESS OTHERWISE SPECIFIED LEADING DIMENSIONS ARE INCHES DIMENSIONS IN [ ] ARE MILLIMETERS

TOLERANCES:	
.X = ±.2 [5]	FRACTIONS ± 1/32
.XX = ±.02 [.5]	ANGLES ± 1°
.XXX = ±.005 [.13]	
CABLE LENGTH TOLERANCES:	
>12 [305] = +1 [25] / -0	
>12 [305] ≤ 60 [1524] = +2 [51] / -0	
>60 [1524] ≤ 120 [3048] = +4 [102] / -0	
>120 [3048] ≤ 300 [7620] = +6 [152] / -0	
>300 [7620] = +5% / -0	

ALL DIMENSIONS ARE FOR REFERENCE ONLY AND SUBJECT TO CHANGE WITHOUT NOTICE.



an INFINITE® brand  
Website: www.L-com.com  
Phone: 1.800.341.5266 | 1.978.682.6936

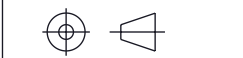

INTERPRET ALL DIMENSIONS AND TOLERANCES PER ASME Y14.5

SCALE	SHEET
NONE	1 OF 1

DESCRIPTION  
617-7125MHZ 3DBI OMNI ANTENNA WITH NMO CONNECTOR  
WHITE

SIZE	CAGE CODE	DRAWN BY	ITEM NO.	REV
A	43321	PSRINIVAS	LCANOM1055	A

6 5 4 3 2 1