

THE INFORMATION CONTAINED IN THIS DRAWING IS THE SOLE PROPERTY OF L-COM, INC. ANY REPRODUCTION IN PART OR WHOLE WITHOUT THE WRITTEN PERMISSION OF L-COM, INC. IS PROHIBITED.

REVISION					
ZONE	REV	DESCRIPTION	DATE	CHANGED BY	APPROVED
	A	INITIAL RELEASE	07/27/2023	PSRINIVAS	GUTTADAURO

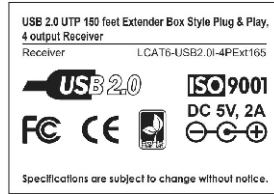

Housing Label-RX  
(50x35mm, black on white)

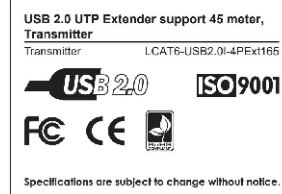

Housing Label-TX  
(50x35mm, black on white)

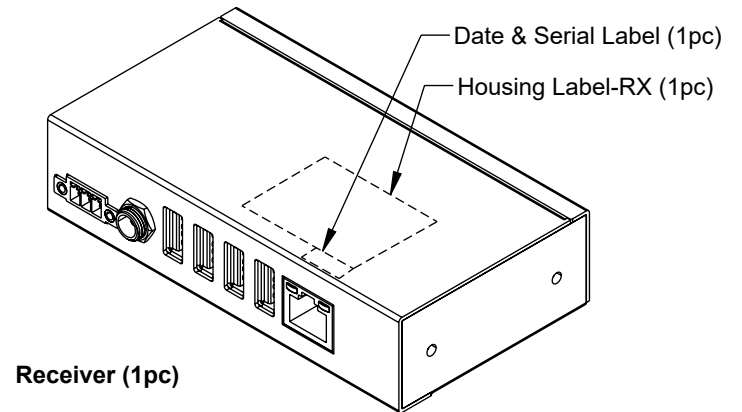
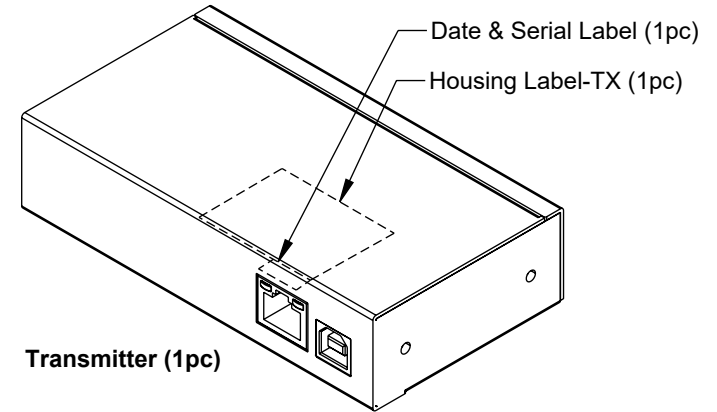

FEATURES:-

- EXTENDS USB TRANSMISSION DISTANCE UP TO 45 METERS / 150 FEET USING CAT5E OR CAT6 UTP SOLID CORE ETHERNET CABLE.
- COMPLIANT WITH USB 2.0 STANDARD AND SUPPORTS SPEEDS UP TO 480MBPS.
- IDEAL FOR USB PERIPHERAL EXTENSION AND DATA TRANSFER
- PLUG AND PLAY WITH NO SOFTWARE REQUIRED AND COMPATIBLE WITH ALL MAJOR OPERATING SYSTEMS
- SUPPORTS WEBCAM STREAMING WITH UP TO 1080P RESOLUTION
- RX (REMOTE) SIDE SUPPORTS 4 PORT USB HUB
- IF USED WITH A USB FLASH, HDD DRIVE OR OTHER PERIPHERAL THAT REQUIRES POWER, THEN AN EXTERNAL POWER SOURCE MUST BE CONNECTED
- SUPPORTS ESD PROTECTION AS 15KV IN CONTACT WITH METAL SHELL
- MATERIAL: SILVER, METAL.
- OPERATING TEMPERATURE RANGE: 32° TO 122° F / 0° TO 50° C
- STORAGE TEMPERATURE RANGE: -4° TO 158° F / -20° TO 70° C
- RELATIVE HUMIDITY: 0 TO 85%, NON-CONDENSING.

NOTES:

- ALL MARKINGS AND LABELS ARE FOR REFERENCE ONLY
- PARTS ARE INDIVIDUALLY PACKAGED
- INCLUDED IN PACKAGE, 1X TX UNIT, 1X RX UNIT, 2X DIN RAIL MOUNTS, 4X M4 MOUNTING SCREWS, 1X RS232 TERMINAL BLOCK, 1X MANUAL, 1X POWER ADAPTER

UNLESS OTHERWISE SPECIFIED, DIMENSIONS ARE IN INCHES [mm]	APPROVALS	DATE	 an INFINIT® brand	50 High Street, West Mill, North Andover, MA 01845 USA. Phone: 1.800.341.5266 1.978.682.6936		
	DRAWN BY PSRINIVAS	07/27/2023				
OVERALL CABLE LENGTH TOLERANCE: ≤12 [305] = +1 [25] / -0 >12 [305] ≤60 [1524] = +2 [51] / -0 >60 [1524] ≤120 [3048] = +4 [102] / -0 >120 [3048] ≤300 [7620] = +6 [152] / -0 >300 [7620] = +5% / -0	CHECKED BY DFRISIELLO	07/27/2023	CATEGORY <b>USB EXTENSION</b>			
ALL OTHER DIMENSIONAL TOLERANCES: .X = ± .2 [5]   FRACTIONS ± 1/32 .XX = ± .02 [5]   ANGLES ± 1° .XXX = ± .005 [1.3]	APPROVED BY GUTTADAURO	07/27/2023	PRODUCT DESCRIPTION <b>INDUSTRIAL LEVEL ESD PROTECTION USB 2.0 UTP EXTENDER WITH ONE REMOTE USB 20 FOUR PORT HUB (UP TO 165 FT OVER 24 AWG SOLID CAT6 CABLE)</b>			
THIRD-ANGLE PROJECTION 	CONFIGURATION DETAILS OF UNDIMENSIONED FEATURES MAY VARY	COLOR VARIATIONS MAY OCCUR	SIZE <b>A</b>	CAGE CODE <b>43321</b>	ITEM NO. <b>LC6-USB20I-4PX165</b>	REV. <b>A</b>
SCALE: NONE			CAD FILE: LC6-USB20I-4PX165.SLDDRW		SHEET 1 OF 4	

THE INFORMATION CONTAINED IN THIS DRAWING IS THE SOLE PROPERTY OF L-COM, INC. ANY REPRODUCTION IN PART OR WHOLE WITHOUT THE WRITTEN PERMISSION OF L-COM, INC. IS PROHIBITED.

REVISION					
ZONE	REV	DESCRIPTION	DATE	CHANGED BY	APPROVED
	A	INITIAL RELEASE	07/27/2023	PSRINIVAS	GUTTADAURO

D  
C  
B  
A

D  
C  
B  
A

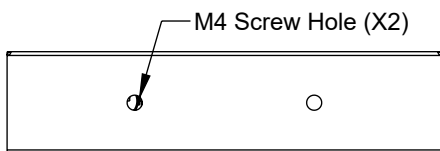

RECEIVER

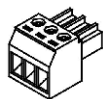
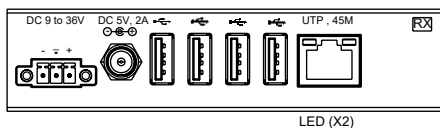
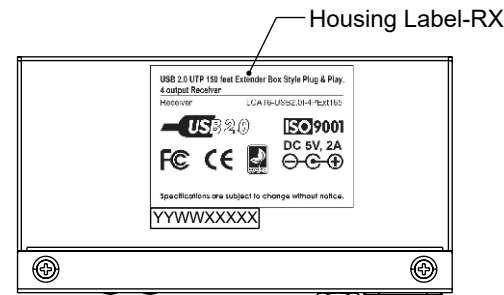
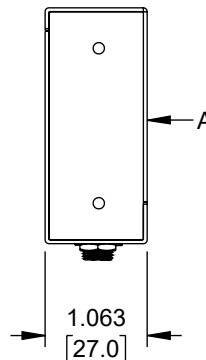
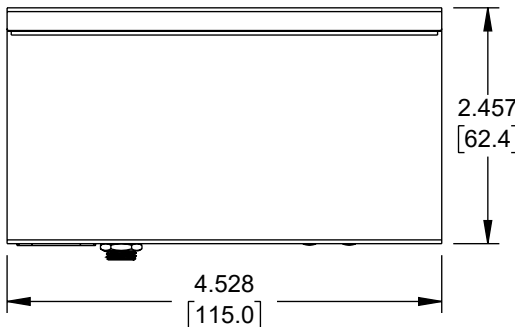

RS232-phenox

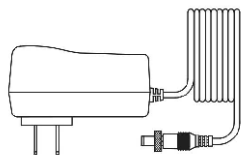

Power adapter  
 Input:100-240V  
 Output:5V, 2A

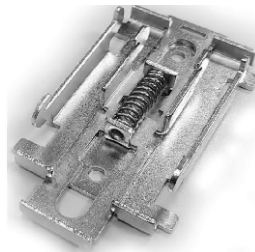

Din Rail Mount



M4 Screw

UNLESS OTHERWISE SPECIFIED, DIMENSIONS ARE IN INCHES [mm]  OVERALL CABLE LENGTH TOLERANCE: ≤12 [305] = +1 [25] / -0 >12 [305] ≤60 [1524] = +2 [51] / -0 >60 [1524] ≤120 [3048] = +4 [102] / -0 >120 [3048] ≤300 [7620] = +6 [152] / -0 >300 [7620] = +5% / -0  ALL OTHER DIMENSIONAL TOLERANCES: .X = ± .2 [5]   FRACTIONS ± 1/32 .XX = ± .02 [5]   ANGLES ± 1° .XXX = ± .005 [1.3]	APPROVALS	DATE	 an INFINIT® brand	50 High Street, West Mill, North Andover, MA 01845 USA. Phone: 1.800.341.5266 1.978.682.6936		
	DRAWN BY PSRINIVAS	07/27/2023				
	CHECKED BY DFRISIELLO	07/27/2023	CATEGORY <b>USB EXTENSION</b>			
	APPROVED BY GUTTADAURO	07/27/2023	PRODUCT DESCRIPTION <b>INDUSTRIAL LEVEL ESD PROTECTION USB 2.0 UTP EXTENDER WITH ONE REMOTE USB 20 FOUR PORT HUB (UP TO 165 FT OVER 24 AWG SOLID CAT6 CABLE)</b>			
THIRD-ANGLE PROJECTION 	CONFIGURATION DETAILS OF UNDIMENSIONED FEATURES MAY VARY	COLOR VARIATIONS MAY OCCUR	SIZE <b>A</b>	CAGE CODE <b>43321</b>	ITEM NO. <b>LC6-USB20I-4PX165</b>	REV. <b>A</b>
			SCALE: NONE	CAD FILE: LC6-USB20I-4PX165.SLDDRW		SHEET 2 OF 4

THE INFORMATION CONTAINED IN THIS DRAWING IS THE SOLE PROPERTY OF L-COM, INC. ANY REPRODUCTION IN PART OR WHOLE WITHOUT THE WRITTEN PERMISSION OF L-COM, INC. IS PROHIBITED.

REVISION					
ZONE	REV	DESCRIPTION	DATE	CHANGED BY	APPROVED
	A	INITIAL RELEASE	07/27/2023	PSRINIVAS	GUTTADAURO

D

C

B

A

D

C

B

A

M4 Screw Hole (x2)

TRANSMITTER

Housing Label-TX

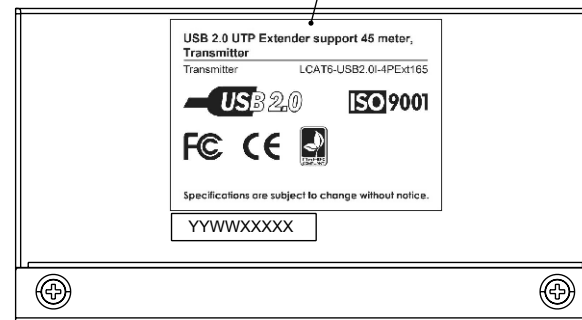
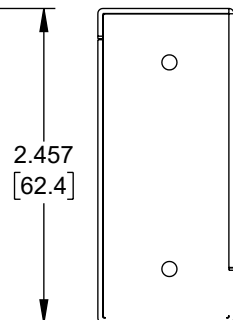
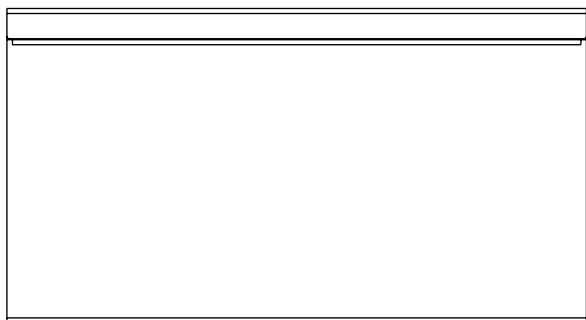
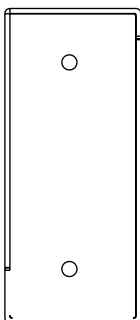

VIEW A

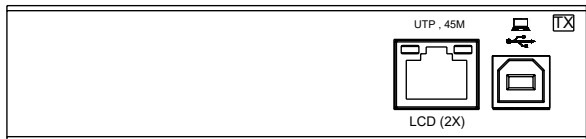

Din Rail Mount



M4 Screw

<p>UNLESS OTHERWISE SPECIFIED, DIMENSIONS ARE IN INCHES [mm]</p> <p>OVERALL CABLE LENGTH TOLERANCE:          ≤12 [305] = +1 [25] / -0          &gt;12 [305] ≤60 [1524] = +2 [51] / -0          &gt;60 [1524] ≤120 [3048] = +4 [102] / -0          &gt;120 [3048] ≤300 [7620] = +6 [152] / -0          &gt;300 [7620] = +5% / -0</p> <p>ALL OTHER DIMENSIONAL TOLERANCES:          .X = ± .2 [5]   FRACTIONS ± 1/32          .XX = ± .02 [5]   ANGLES ± 1°          .XXX = ± .005 [1.3]</p> <p>THIRD-ANGLE PROJECTION</p>	<p>APPROVALS</p> <p>DRAWN BY PSRINIVAS</p> <p>CHECKED BY DFRISIELLO</p> <p>APPROVED BY GUTTADAURO</p>	<p>DATE</p> <p>07/27/2023</p> <p>07/27/2023</p> <p>07/27/2023</p>	<p><b>L-com</b> an INFINITI® brand</p> <p>50 High Street, West Mill, North Andover, MA 01845 USA. Phone: 1.800.341.5266 1.978.682.6936</p>
	<p>CONFIGURATION DETAILS OF UNDIMENSIONED FEATURES MAY VARY</p> <p>COLOR VARIATIONS MAY OCCUR</p>	<p>PRODUCT DESCRIPTION</p> <p>INDUSTRIAL LEVEL ESD PROTECTION USB 2.0 UTP EXTENDER WITH ONE REMOTE USB 20 FOUR PORT HUB (UP TO 165 FT OVER 24 AWG SOLID CAT6 CABLE)</p>	<p>CATEGORY</p> <p>USB EXTENSION</p>
SCALE: NONE		CAD FILE: LC6-USB20I-4PX165.SLDDRW	
			SHEET 3 OF 4

THE INFORMATION CONTAINED IN THIS DRAWING IS THE SOLE PROPERTY OF L-COM, INC. ANY REPRODUCTION IN PART OR WHOLE WITHOUT THE WRITTEN PERMISSION OF L-COM, INC. IS PROHIBITED.

REVISION					
ZONE	REV	DESCRIPTION	DATE	CHANGED BY	APPROVED
	A	INITIAL RELEASE	07/27/2023	PSRINIVAS	GUTTADAURO

## PANEL DESCRIPTION

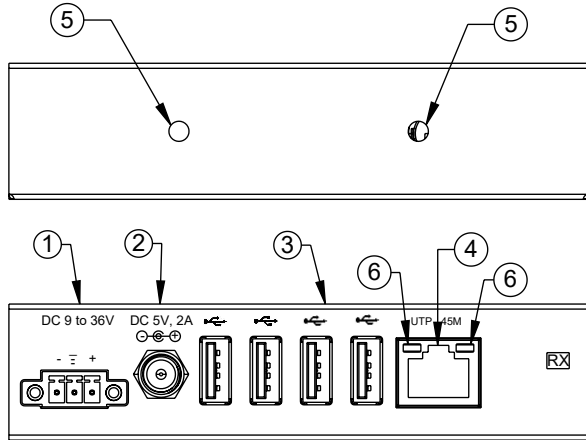

### RECEIVER UNIT:-

1. PHOENIX CONNECTOR FOR EXTERNAL POWER IN 9V~36V (OPTIONAL)
2. DC POWER IN
3. USB OUTPUT – CONNECT TO USB-A DEVICE, SUCH AS KEYBOARD, MOUSE, USB FLASH, USB HDD, ETC.
4. RJ-45 INPUT – CONNECT A CAT 6 CABLE FROM TRANSMITTER TO THIS RJ-45 JACK AS SIGNAL INPUT
5. DIN RAIL SCREWFIX

### LED DESCRIPTION:-

6. RJ-45 JACK LED INDICATOR – LEFT SIDE

GREEN LED LIGHT WILL BE ON WHEN RECEIVER RECEIVED SIGNAL FROM TRANSMITTER

### RIGHT SIDE

ORANGE LED LIGHT SHOULD BLINK WHEN DATA IS BEING TRANSMITTED.

### NOTICE: -

IF CONNECTING TO A HIGH DENSITY USB FLASH, HDD OR OTHER USB DEVICE THAT REQUIRES USB BUS POWER, THE RX UNIT REQUIRES EXTERNAL POWER VIA THE TERMINAL BLOCK OR DC INPUT TO PROVIDE SAID POWER.

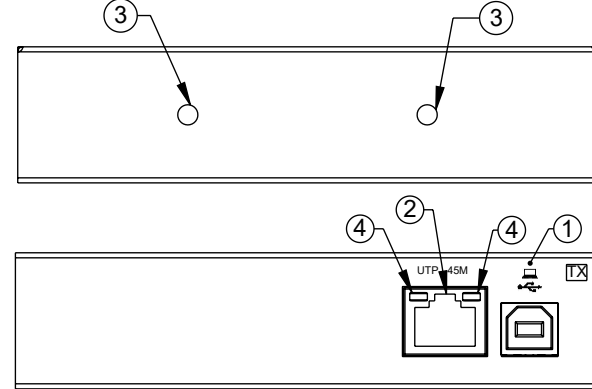

### TRANSMITTER UNIT:-

1. USB INPUT – CONNECT TO SOURCE SUCH AS PC/NOTEBOOK, ETC.
2. RJ-45 OUTPUT – CONNECT A CAT 6 CABLES TO EXTEND SIGNAL
3. DIN RAIL SCREWFIX

### LED DESCRIPTION:-

4. RJ-45 2 SIDE LED INDICATOR – LEFT SIDE

GREEN LED LIGHT WILL BE ON WHEN TRANSMITTER CONNECTS TO RECEIVER.

### RIGHT SIDE

ORANGE LED LIGHT WILL BE ONE WHEN TRANSMITTER SENDS SIGNAL THROUGH THE RJ-45 JACK.

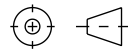
UNLESS OTHERWISE SPECIFIED, DIMENSIONS ARE IN INCHES [mm] OVERALL CABLE LENGTH TOLERANCE: ≤12 [305] = +1 [25] / -0 >12 [305] ≤60 [1524] = +2 [51] / -0 >60 [1524] ≤120 [3048] = +4 [102] / -0 >120 [3048] ≤300 [7620] = +6 [152] / -0 >300 [7620] = +5% / -0 ALL OTHER DIMENSIONAL TOLERANCES: .X = ± .2 [5]   FRACTIONS ± 1/32 .XX = ± .02 [.5]   ANGLES ± 1° .XXX = ± .005 [.13]	APPROVALS PSRINIVAS	DATE 07/27/2023	 50 High Street, West Mill, North Andover, MA 01845 USA. Phone: 1.800.341.5266 1.978.682.6936			
	CHECKED BY DFRISIELLO	DATE 07/27/2023		CATEGORY USB EXTENSION		
THIRD-ANGLE PROJECTION 	CONFIGURATION DETAILS OF UNDIMENSIONED FEATURES MAY VARY	PRODUCT DESCRIPTION INDUSTRIAL LEVEL ESD PROTECTION USB 2.0 UTP EXTENDER WITH ONE REMOTE USB 20 FOUR PORT HUB (UP TO 165 FT OVER 24 AWG SOLID CAT6 CABLE)	SIZE A	CAGE CODE 43321	ITEM NO. LC6-USB20I-4PX165	REV. A
COLOR VARIATIONS MAY OCCUR		SCALE: NONE	CAD FILE: LC6-USB20I-4PX165.SLDDRW	SHEET 4 OF 4		