

THE INFORMATION CONTAINED IN THIS DRAWING IS THE SOLE PROPERTY OF L-COM, INC. ANY REPRODUCTION IN PART OR WHOLE WITHOUT THE WRITTEN PERMISSION OF L-COM, INC. IS PROHIBITED.

REVISION					
ZONE	REV	DESCRIPTION	DATE	CHANGED BY	APPROVED
	A	INITIAL RELEASE	07/27/2023	PSRINIVAS	GUTTADAURO

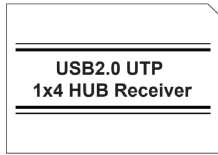

Housing Label-RX1
(34.4x24.4mm, silver)



Housing Label-RX2
(34.4x24.4mm, silver)



PCB Label
(15x6mm, white)



Date & Serial Label
(18x7mm, black on silver)

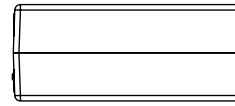
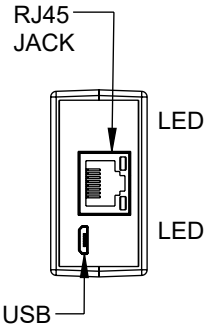

Housing Label RX1

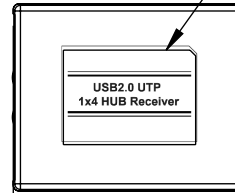

2.42 [61.5]



USB-A

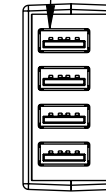

1.00 [25.5]

Housing Label RX2

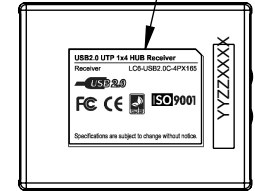

FEATURES:-

- EXTENDS USB TRANSMISSION DISTANCE UP TO 50 METERS / 165 FEET USING CAT5E OR CAT6 UTP SOLID CORE ETHERNET CABLE
- COMPLIANT WITH USB 2.0 STANDARD AND SUPPORTS SPEEDS UP TO 480MBPS
- IDEAL FOR USB PERIPHERAL EXTENSION AND DATA TRANSFER
- PLUG AND PLAY WITH NO SOFTWARE REQUIRED AND COMPATIBLE WITH ALL MAJOR OPERATING SYSTEMS
- SUPPORTS WEBCAM STREAMING WITH UP TO 1080P RESOLUTION
- IF USED WITH A USB FLASH OR HDD DRIVE THAT REQUIRES POWER, THEN AN EXTERNAL POWER SOURCE OF AT LEAST 5V MUST BE CONNECTED VIA THE MICRO USB POWER PORT
- MATERIAL: BLACK, PC PLASTIC
- OPERATING TEMPERATURE RANGE: 32° TO 104° F / 0° TO 40° C
- STORAGE TEMPERATURE RANGE: 5° TO 122° F / -15° TO 50° C
- RELATIVE HUMIDITY: 0 TO 85%, NON-CONDENSING.

NOTES:

- ALL MARKINGS AND LABELS ARE FOR REFERENCE ONLY.
- PARTS ARE INDIVIDUALLY PACKAGED.
- INCLUDED IN PACKAGE, 1X TX UNIT, 1X RX UNIT, 1X MANUAL.

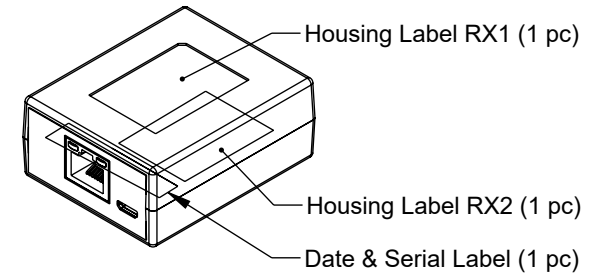

UNLESS OTHERWISE SPECIFIED, DIMENSIONS ARE IN INCHES [mm]

OVERALL CABLE LENGTH TOLERANCE:
 ≤12 [305] = +1 [25] / -0
 >12 [305] ≤60 [1524] = +2 [51] / -0
 >60 [1524] ≤120 [3048] = +4 [102] / -0
 >120 [3048] ≤300 [7620] = +6 [152] / -0
 >300 [7620] = +5% / -0

ALL OTHER DIMENSIONAL TOLERANCES:
 .X = ± .2 [5] | FRACTIONS ± 1/32
 .XX = ± .02 [5] | ANGLES ± 1°
 .XXX = ± .005 [1.3]

THIRD-ANGLE PROJECTION

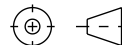

APPROVALS	DATE
DRAWN BY PSRINIVAS	07/27/2023
CHECKED BY DFRISIELLO	07/27/2023
APPROVED BY GUTTADAURO	07/27/2023

L-com
an INFINIT® brand

50 High Street, West Mill,
North Andover, MA 01845 USA.
Phone: 1.800.341.5266
1.978.682.6936

CATEGORY: **USB EXTENSION**

PRODUCT DESCRIPTION:
USB 20 UTP EXTENDER WITH ONE REMOTE USB 2.0 FOUR PORT HUB (UP TO 165 FT OVER 24 AWG SOLID CAT6 CABLE)

SIZE	CAGE CODE	ITEM NO.	REV.
A	43321	LC6-USB20C-4PX165	A

SCALE: NONE | CAD FILE: LC6-USB20C-4PX165.SLDDRW | SHEET 1 OF 3

THE INFORMATION CONTAINED IN THIS DRAWING IS THE SOLE PROPERTY OF L-COM, INC. ANY REPRODUCTION IN PART OR WHOLE WITHOUT THE WRITTEN PERMISSION OF L-COM, INC. IS PROHIBITED.

REVISION					
ZONE	REV	DESCRIPTION	DATE	CHANGED BY	APPROVED
	A	INITIAL RELEASE	07/27/2023	PSRINIVAS	GUTTADAURO

D

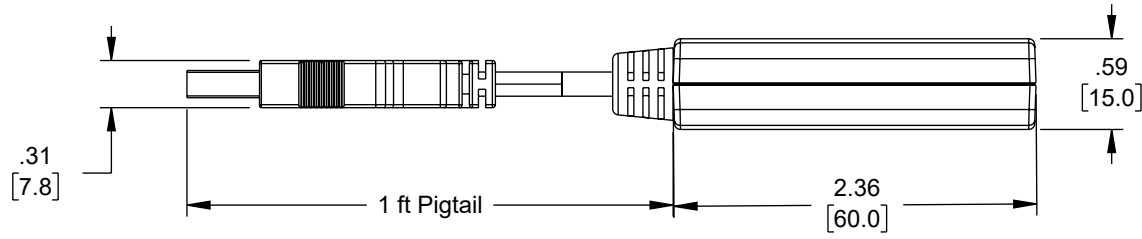

PCB Label
(15x6mm,white)

Date & Serial Label
(18x7mm,black on silver)

YYWWXXXXX

C

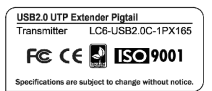
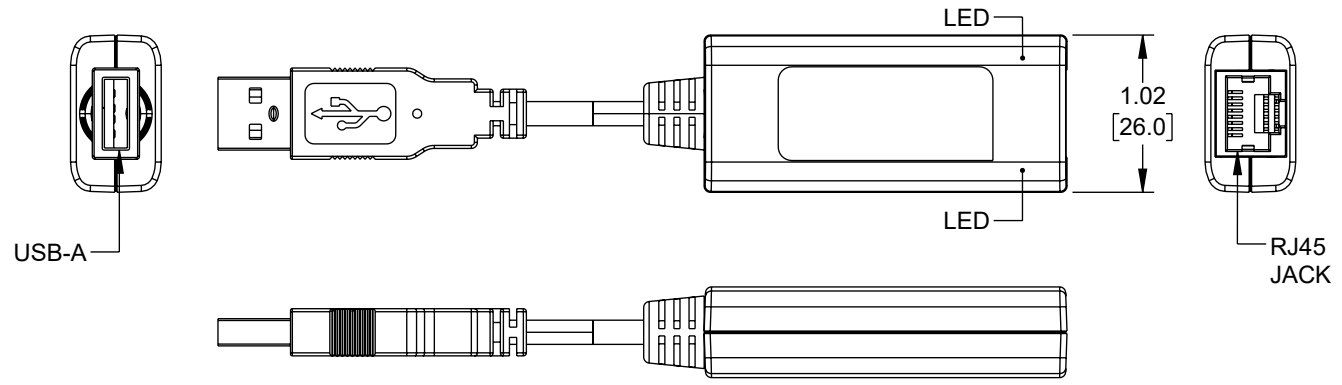

B

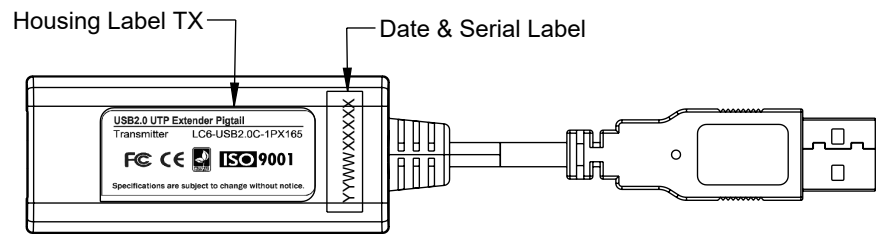

A

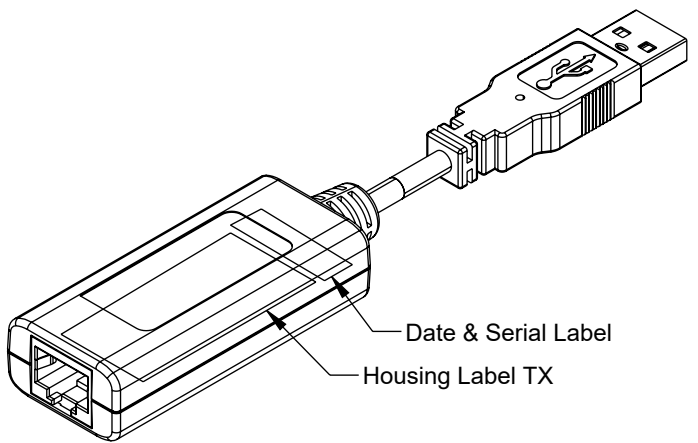

<p>UNLESS OTHERWISE SPECIFIED, DIMENSIONS ARE IN INCHES [mm]</p> <p>OVERALL CABLE LENGTH TOLERANCE: ≤12 [305] = +1 [25] / -0 >12 [305] ≤60 [1524] = +2 [51] / -0 >60 [1524] ≤120 [3048] = +4 [102] / -0 >120 [3048] ≤300 [7620] = +6 [152] / -0 >300 [7620] = +5% / -0</p> <p>ALL OTHER DIMENSIONAL TOLERANCES: .X = ± .2 [5] FRACTIONS ± 1/32 .XX = ± .02 [5] ANGLES ± 1° .XXX = ± .005 [13]</p> <p>THIRD-ANGLE PROJECTION</p>	<p>APPROVALS</p> <p>DRAWN BY PSRINIVAS</p> <p>CHECKED BY DFRISIELLO</p> <p>APPROVED BY GUTTADAURO</p>	<p>DATE</p> <p>07/27/2023</p> <p>07/27/2023</p> <p>07/27/2023</p>	<p>L-com an INFINITI® brand</p> <p>50 High Street, West Mill, North Andover, MA 01845 USA. Phone: 1.800.341.5266 1.978.682.6936</p>
	<p>CONFIGURATION DETAILS OF UNDIMENSIONED FEATURES MAY VARY</p>		<p>CATEGORY</p> <p>USB EXTENSION</p>
	<p>COLOR VARIATIONS MAY OCCUR</p>		<p>PRODUCT DESCRIPTION</p> <p>USB 20 UTP EXTENDER WITH ONE REMOTE USB 2.0 FOUR PORT HUB (UP TO 165 FT OVER 24 AWG SOLID CAT6 CABLE)</p>
	<p>SIZE</p> <p>A</p>	<p>CAGE CODE</p> <p>43321</p>	<p>ITEM NO.</p> <p>LC6-USB20C-4PX165</p>

A

B

C

D

THE INFORMATION CONTAINED IN THIS DRAWING IS THE SOLE PROPERTY OF L-COM, INC. ANY REPRODUCTION IN PART OR WHOLE WITHOUT THE WRITTEN PERMISSION OF L-COM, INC. IS PROHIBITED.

REVISION					
ZONE	REV	DESCRIPTION	DATE	CHANGED BY	APPROVED
	A	INITIAL RELEASE	07/27/2023	PSRINIVAS	GUTTADAURO

PANEL DESCRIPTION

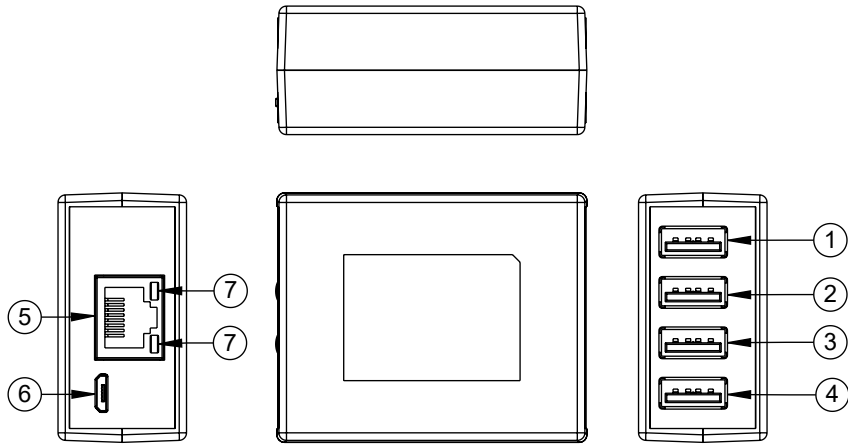

RECEIVER UNIT:-

1. USB-A 2.0 OUTPUT – SAME AS 2, 3, 4 CONNECT TO USB-A DEVICE, SUCH AS KEYBOARD, MOUSE, USB FLASH, USB HDD, ETC.
5. RJ-45 INPUT – CONNECT A CAT 6 CABLE FROM TRANSMITTER TO THIS RJ-45 JACK AS SIGNAL INPUT.
6. MICRO USB-B INPUT - IF THE END DEVICE REQUIRES USB POWER SUCH AS A FLASH DRIVE, PORTABLE HDD OR OTHER USB DEVICE THAT REQUIRES USB BUS POWER, A 5V POWER SOURCE MUST BE CONNECTED VIA THE MICRO USB PORT TO PROVIDE SAID POWER.

LED DESCRIPTION:-

7. RJ-45 JACK LED INDICATOR – LEFT SIDE

GREEN LED LIGHT WILL BE ON WHEN RECEIVER RECEIVED SIGNAL FROM TRANSMITTER

RIGHT SIDE

ORANGE LED LIGHT SHOULD BLINK WHEN DATA IS BEING TRANSMITTED.

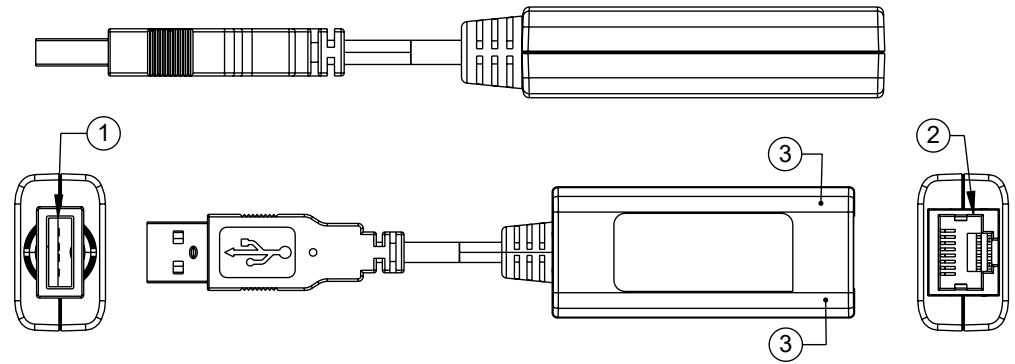

TRANSMITTER UNIT:-

1. USB-A 2.0 INPUT PIGTAIL – CONNECT TO SOURCE SUCH AS PC/NOTEBOOK, ETC.
2. RJ-45 OUTPUT – CONNECT A CAT 6 CABLES TO EXTEND SIGNAL

LED DESCRIPTION:-

3. RJ-45 2 SIDE LED INDICATOR – LEFT SIDE

GREEN LED LIGHT WILL BE ON WHEN TRANSMITTER CONNECTS TO RECEIVER.

RIGHT SIDE

ORANGE LED LIGHT WILL BE ON WHEN TRANSMITTER SENDS SIGNAL THROUGH THE RJ-45 JACK..

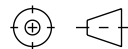
UNLESS OTHERWISE SPECIFIED, DIMENSIONS ARE IN INCHES [mm] OVERALL CABLE LENGTH TOLERANCE: ≤12 [305] = +1 [25] / -0 >12 [305] ≤60 [1524] = +2 [51] / -0 >60 [1524] ≤120 [3048] = +4 [102] / -0 >120 [3048] ≤300 [7620] = +6 [152] / -0 >300 [7620] = +5% / -0 ALL OTHER DIMENSIONAL TOLERANCES: .X = ± .2 [5] FRACTIONS ± 1/32 .XX = ± .02 [5] ANGLES ± 1° .XXX = ± .005 [13]	APPROVALS	DATE	 50 High Street, West Mill, North Andover, MA 01845 USA. Phone: 1.800.341.5266 1.978.682.6936
	DRAWN BY PSRINIVAS	07/27/2023	
APPROVED BY GUTTADAURO	07/27/2023	CATEGORY USB EXTENSION	
THIRD-ANGLE PROJECTION 	CONFIGURATION DETAILS OF UNDIMENSIONED FEATURES MAY VARY	PRODUCT DESCRIPTION USB 20 UTP EXTENDER WITH ONE REMOTE USB 2.0 FOUR PORT HUB (UP TO 165 FT OVER 24 AWG SOLID CAT6 CABLE)	SIZE A
COLOR VARIATIONS MAY OCCUR	CAGE CODE 43321	ITEM NO. LC6-USB20C-4PX165	REV. A
SCALE: NONE		CAD FILE: LC6-USB20C-4PX165.SLDDRW	
			SHEET 3 OF 3