

6

5

4

3

2

1

REVISION					
ZONE	REV	DESCRIPTION	DATE	CHANGED BY	APPROVED
	A	INITIAL RELEASE	07/18/2023	DZINN	THOUGHTON

CABLE MANAGEMENT PLATE  
TOP & BOTTOM

□ 4.13  
[105]

8X  $\phi$  .177 [4.50] THRU

23.62  
[600]

46.68  
[1185.7]

35.62  
[904.8]

23.62  
[600]

GLASS DOOR

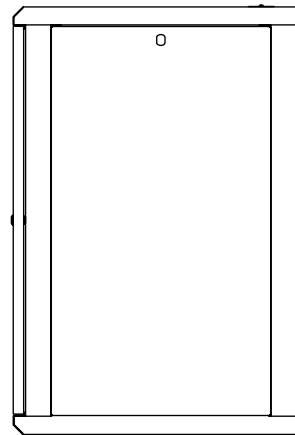
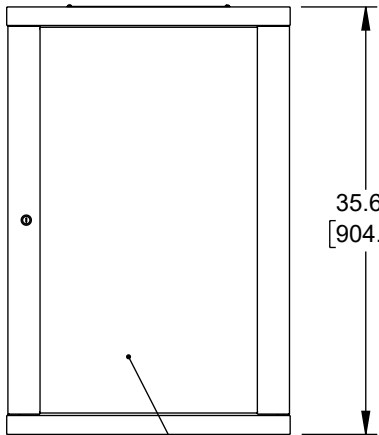
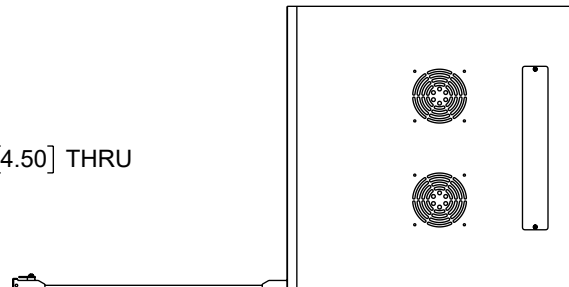
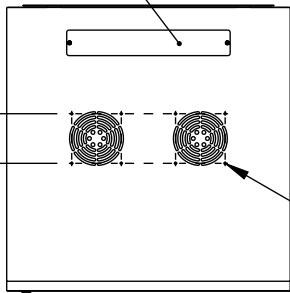
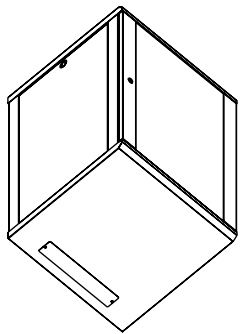
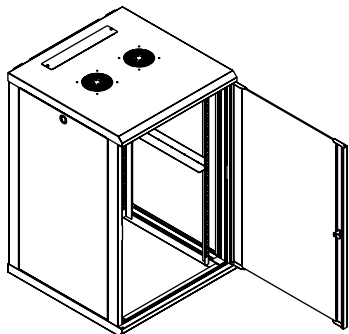

THE INFORMATION CONTAINED IN THIS DRAWING IS THE SOLE PROPERTY OF INFINITE ELECTRONICS, INC. ANY REPRODUCTION IN PART OR WHOLE WITHOUT THE WRITTEN PERMISSION OF INFINITE ELECTRONICS, INC. IS PROHIBITED. THESE COMMODITIES, TECHNOLOGY OR SOFTWARE WERE EXPORTED FROM THE UNITED STATES IN ACCORDANCE WITH THE EXPORT ADMINISTRATION REGULATIONS. DIVERSION CONTRARY TO U.S. LAW PROHIBITED.

UNLESS OTHERWISE SPECIFIED  
LEADING DIMENSIONS ARE INCHES  
DIMENSIONS IN [ ] ARE MILLIMETERS

TOLERANCES:  
X = ±.2 [5]      FRACTIONS ± 1/32  
.XX = ±.02 [0.5]      ANGLES ± 1°  
.XXX = ±.005 [0.13]

CABLE LENGTH TOLERANCES:  
≤12 [305] = +1 [25] / -0  
>12 [305] ≤ 60 [1524] = +2 [51] / -0  
>60 [1524] ≤ 120 [3048] = +4 [102] / -0  
>120 [3048] ≤ 300 [7620] = +6 [152] / -0  
>300 [7620] = +5% / -0

ALL DIMENSIONS ARE FOR REFERENCE ONLY  
AND SUBJECT TO CHANGE WITHOUT NOTICE.  
UN-DIMENSIONED/NON-CRITICAL FEATURES  
MAY VARY IN SIZE AND LOCATION  
COLORS MAY VARY

**Show Me**  
CABLES

an INFINITIB brand

Website: [www.ShowMeCables.com](http://www.ShowMeCables.com)  
Phone: 1.888.519.9505

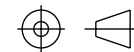

INTERPRET ALL DIMENSIONS AND  
TOLERANCES PER ASME Y14.5

SCALE  
NONE

SHEET  
1 OF 1

DESCRIPTION  
19IN WALL MOUNT CABINET, 18U, 23IN [600mm] DEEP

SIZE A	CAGE CODE 3SVT8	DRAWN BY DZINN	ITEM NO. LC-SMA6618-W	REV A
-----------	--------------------	-------------------	--------------------------	----------

6

5

4

3

2

1

F

E

D

C

B

A

F

E

D

C

B

A