

6

5

4

3

2

1

REVISION					
ZONE	REV.	DESCRIPTION	DATE	CHANGED BY	APPROVED BY
	A	INITIAL RELEASE	07/18/2023	DZINN	THOUGHTON

CABLE MANAGEMENT PANEL
TOP & BOTTOM

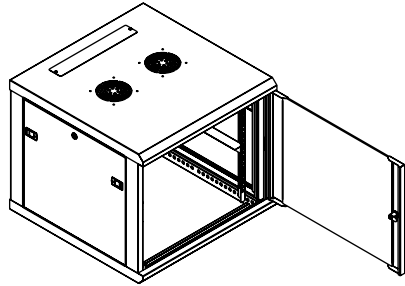

□ 4.13
[105]

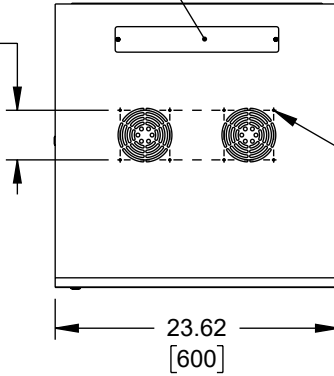

8X Ø.177 [4.50] THRU

23.62
[600]

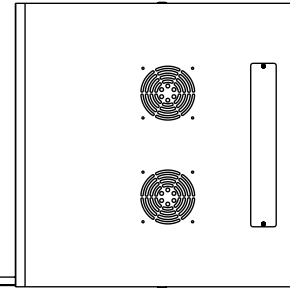

46.39
[1178.2]

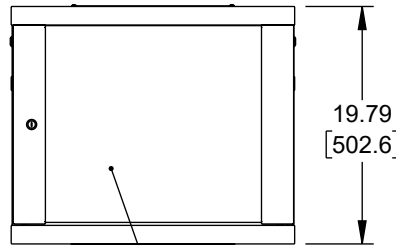
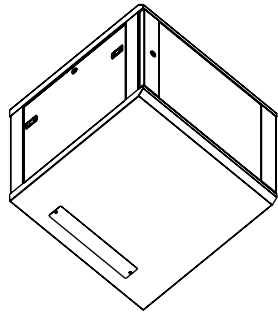

19.79
[502.6]

GLASS DOOR

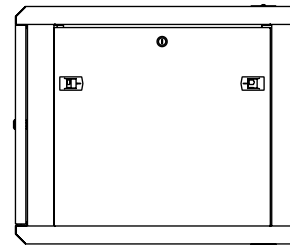

23.62
[600]

THE INFORMATION CONTAINED IN THIS DRAWING IS THE SOLE PROPERTY OF INFINITE ELECTRONICS, INC. ANY REPRODUCTION IN PART OR WHOLE WITHOUT THE WRITTEN PERMISSION OF INFINITE ELECTRONICS, INC. IS PROHIBITED. THESE COMMODITIES, TECHNOLOGY OR SOFTWARE WERE EXPORTED FROM THE UNITED STATES IN ACCORDANCE WITH THE EXPORT ADMINISTRATION REGULATIONS. DIVERSION CONTRARY TO U.S. LAW PROHIBITED.

UNLESS OTHERWISE SPECIFIED
LEADING DIMENSIONS ARE INCHES
DIMENSIONS IN [] ARE MILLIMETERS

TOLERANCES:
 X = ±.2 [5] FRACTIONS ± 1/32
 .XX = ±.02 [0.5] ANGLES ± 1°
 .XXX = ±.005 [0.13]

CABLE LENGTH TOLERANCES:
 ≤12 [305] = +1 [25] / -0
 >12 [305] ≤ 60 [1524] = +2 [51] / -0
 >60 [1524] ≤ 120 [3048] = +4 [102] / -0
 >120 [3048] ≤ 300 [7620] = +6 [152] / -0
 >300 [7620] = +5% / -0

ALL DIMENSIONS ARE FOR REFERENCE ONLY
AND SUBJECT TO CHANGE WITHOUT NOTICE.
UN-DIMENSIONED/NON-CRITICAL FEATURES
MAY VARY IN SIZE AND LOCATION
COLORS MAY VARY

Show Me
CABLES

an INFINIT® brand

Website: www.ShowMeCables.com
Phone: 1.888.519.9505

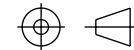

INTERPRET ALL DIMENSIONS AND TOLERANCES PER ASME Y14.5

SCALE NONE SHEET 1 OF 1

DESCRIPTION
19IN WALL MOUNT CABINET, 9U, 23IN [600mm] DEEP

SIZE A	CAGE CODE 3SVT8	DRAWN BY DZINN	ITEM NO. LC-SMA6609-W	REV A
-----------	--------------------	-------------------	--------------------------	----------

6

5

4

3

2

1