

THE INFORMATION CONTAINED IN THIS DRAWING IS THE SOLE PROPERTY OF L-COM, INC. ANY REPRODUCTION IN PART OR WHOLE WITHOUT THE WRITTEN PERMISSION OF L-COM, INC. IS PROHIBITED.

REVISIONS			
REV	DESCRIPTION	DATE	APPROVED
A	INITIAL RELEASE	2/18/22	PHOSPOSAR

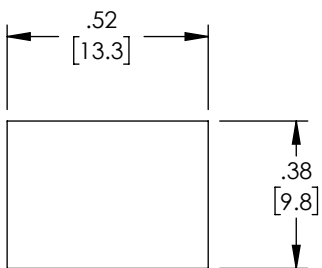

RECOMMENDED PANEL CUTOUT

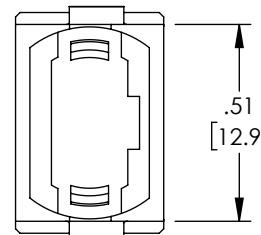
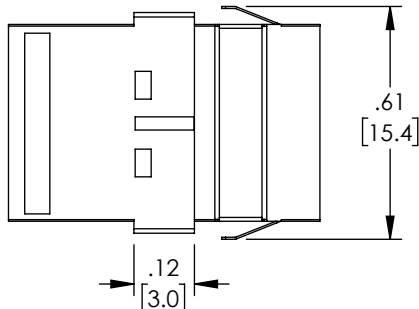
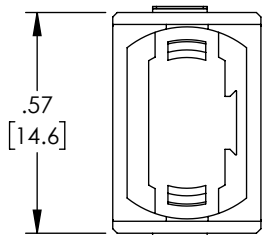
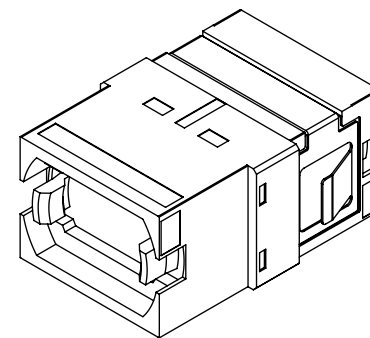
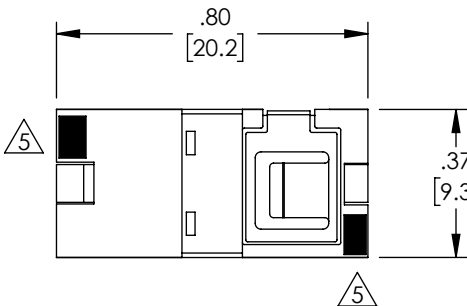

NOTES:

- ALL DIMENSIONS ARE FOR REFERENCE ONLY.
 - DUST CAPS NOT SHOWN.
 - RECOMMENDED PANEL THICKNESS: .06" [1.5]
 - COMPONENT SHALL BE INDIVIDUALLY PACKAGED IN ACCORDANCE WITH L-COM SPECIFICATION PS-0031.
- 5 WHITE MARK FOR KEY UP-KEY DOWN

REGULATORY COMPLIANCE:

EU RoHS DIRECTIVE (MOST RECENT RELEASED VERSION)

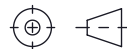
UNLESS OTHERWISE SPECIFIED, DIMENSIONS ARE IN INCHES [mm] OVERALL CABLE LENGTH TOLERANCE: ≤12 [305] = +1 [25] / -0 >12 [305] ≤60 [1524] = +2 [51] / -0 >60 [1524] ≤120 [3048] = +4 [102] / -0 >120 [3048] ≤300 [7620] = +6 [152] / -0 >300 [7620] = +5% / -0 ALL OTHER DIMENSIONAL TOLERANCES: .X = ± .2 [5] FRACTIONS ± 1/32 .XX = ± .02 [5] ANGLES ± 1° .XXX = ± .005 [13]	APPROVALS	DATE	 50 High Street, West Mill, North Andover, MA 01845 USA. Phone: 1.800.341.5266 1.978.682.6936		
	DRAWN BY DMAY	2/9/22		CATEGORY FIBER OPTICS	
	CHECKED BY BSTUSAK	2/18/22			
	APPROVED BY PHOSPODAR	2/18/22			
THIRD-ANGLE PROJECTION	CONFIGURATION DETAILS OF UNDIMENSIONED FEATURES MAY VARY	PRODUCT DESCRIPTION MPO SIMPLEX COUPLER, TRANSLUCENT INTERNAL SHUTTER, KEY UP-KEY DOWN, BLACK/GREEN			
	COLOR VARIATIONS MAY OCCUR	SIZE A	CAGE CODE 43321	ITEM NO. FOA-825-GRN	REV. A
SCALE: NONE		CAD FILE: FOA-825-GRN.SLDDRW		SHEET 1 OF 1	