

THE INFORMATION CONTAINED IN THIS DRAWING IS THE SOLE PROPERTY OF L-COM, INC. ANY REPRODUCTION IN PART OR WHOLE WITHOUT THE WRITTEN PERMISSION OF L-COM, INC. IS PROHIBITED.

| REVISIONS | | | |
|-----------|-----------------|---------|-----------|
| REV | DESCRIPTION | DATE | APPROVED |
| A | INITIAL RELEASE | 2/18/22 | PHOSPODAR |
| | | | |
| | | | |

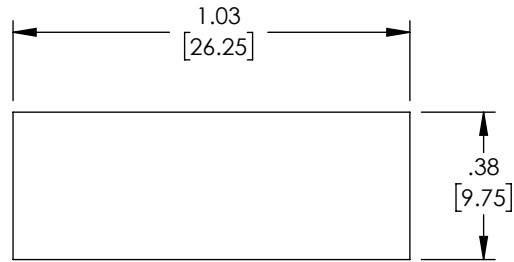

RECOMMENDED
PANEL CUTOUT

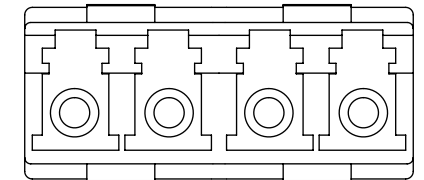
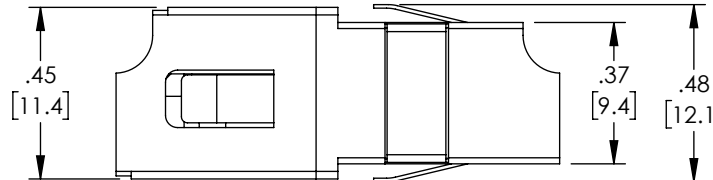
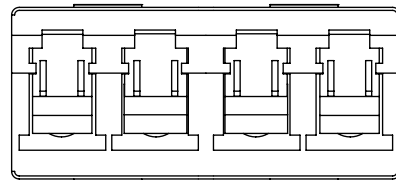
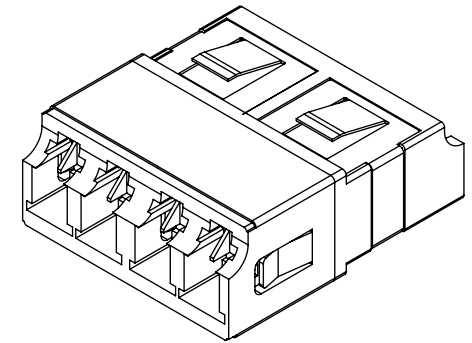
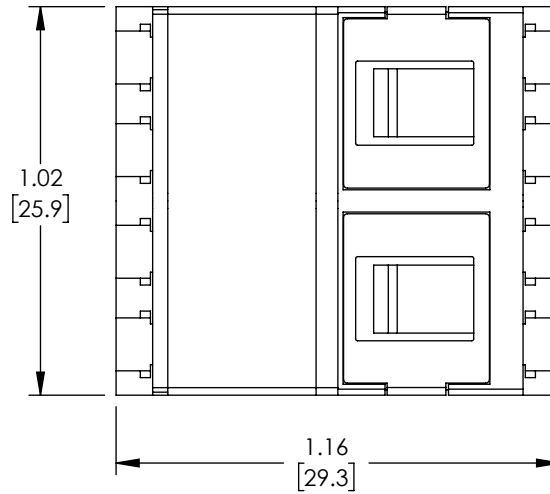

- NOTES:
1. ALL DIMENSIONS ARE FOR REFERENCE ONLY.
 2. DUST CAPS NOT SHOWN.
 3. RECOMMENDED PANEL THICKNESS: .06" [1.5]
 4. COMPONENT SHALL BE INDIVIDUALLY PACKAGED IN ACCORDANCE WITH L-COM SPECIFICATION PS-0031.

REGULATORY COMPLIANCE:
EU RoHS DIRECTIVE (MOST RECENT RELEASED VERSION)

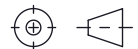
| | | | | |
|---|--|---|---|-------------------------------------|
| UNLESS OTHERWISE SPECIFIED, DIMENSIONS ARE IN INCHES [mm] OVERALL CABLE LENGTH TOLERANCE: ≤12 [305] = +1 [25] / -0 >12 [305] ≤60 [1524] = +2 [51] / -0 >60 [1524] ≤120 [3048] = +4 [102] / -0 >120 [3048] ≤300 [7620] = +6 [152] / -0 >300 [7620] = +5% / -0 ALL OTHER DIMENSIONAL TOLERANCES: .X = ± .2 [5] FRACTIONS ± 1/32 .XX = ± .02 [5] ANGLES ± 1° .XXX = ± .005 [13] | APPROVALS | DATE |  50 High Street, West Mill, North Andover, MA 01845 USA. Phone: 1.800.341.5266 1.978.682.6936 | |
| | DRAWN BY DMAY | 2/14/22 | | CATEGORY FIBER OPTICS |
| | CHECKED BY BSTUSAK | 2/18/22 | | |
| | APPROVED BY PHOSPODAR | 2/18/22 | | |
| THIRD-ANGLE PROJECTION  | CONFIGURATION DETAILS OF UNDIMENSIONED FEATURES MAY VARY | PRODUCT DESCRIPTION FIBER COUPLER, LC/LC QUAD, WHITE INTERNAL SHUTTER, VERTICAL SPRING, HIGH DENSITY, GREEN | SIZE A | |
| | COLOR VARIATIONS MAY OCCUR | CAGE CODE 43321 | ITEM NO. FOA-817-GRN | |
| | | SCALE: NONE | SHEET 1 OF 1 CAD FILE: FOA-817-GRN.SLDDRW | |