

THE INFORMATION CONTAINED IN THIS DRAWING IS THE SOLE PROPERTY OF L-COM, INC. ANY REPRODUCTION IN PART OR WHOLE WITHOUT THE WRITTEN PERMISSION OF L-COM, INC. IS PROHIBITED.

REVISIONS			
REV	DESCRIPTION	DATE	APPROVED
A	INITIAL RELEASE	2/18/22	PHOSPODAR

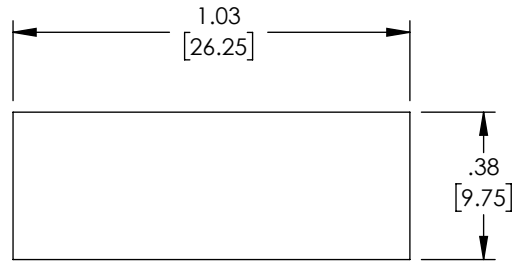

RECOMMENDED  
PANEL CUTOUT

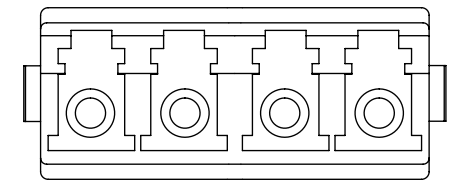
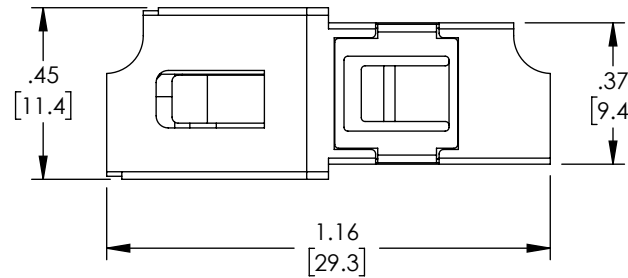
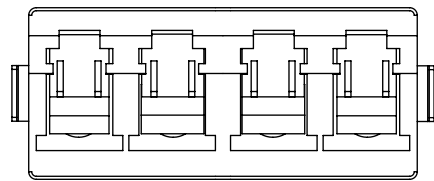
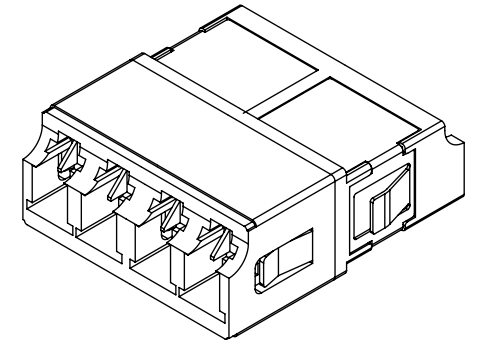
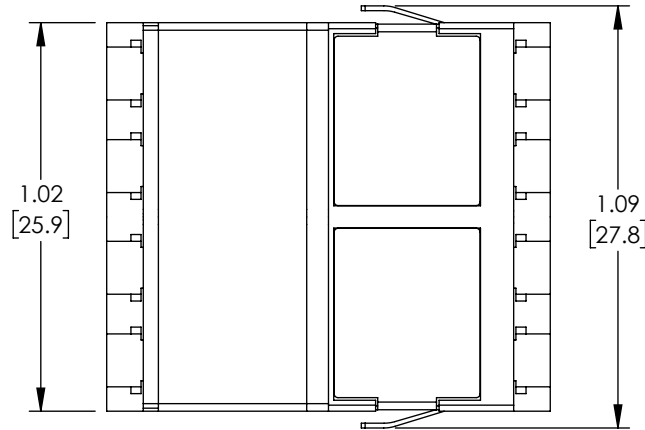

- NOTES:
1. ALL DIMENSIONS ARE FOR REFERENCE ONLY.
  2. DUST CAPS NOT SHOWN.
  3. RECOMMENDED PANEL THICKNESS: .06" [1.5]
  4. COMPONENT SHALL BE INDIVIDUALLY PACKAGED IN ACCORDANCE WITH L-COM SPECIFICATION PS-0031.

**REGULATORY COMPLIANCE:**  
EU RoHS DIRECTIVE (MOST RECENT RELEASED VERSION)

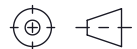
UNLESS OTHERWISE SPECIFIED, DIMENSIONS ARE IN INCHES [mm]  OVERALL CABLE LENGTH TOLERANCE: ≤12 [305] = +1 [25] / -0 >12 [305] ≤60 [1524] = +2 [51] / -0 >60 [1524] ≤120 [3048] = +4 [102] / -0 >120 [3048] ≤300 [7620] = +6 [152] / -0 >300 [7620] = +5% / -0  ALL OTHER DIMENSIONAL TOLERANCES: .X = ± .2 [5]      FRACTIONS ± 1/32 .XX = ± .02 [.5]      ANGLES ± 1° .XXX = ± .005 [.13]	APPROVALS	DATE	 an INFINITO brand	50 High Street, West Mill, North Andover, MA 01845 USA. Phone: 1.800.341.5266 1.978.682.6936	
	DRAWN BY DMAY	2/15/22			CATEGORY  <b>FIBER OPTICS</b>
	CHECKED BY BSTUSAK	2/18/22			
	APPROVED BY PHOSPODAR	2/18/22			
THIRD-ANGLE PROJECTION	CONFIGURATION DETAILS OF UNDIMENSIONED FEATURES MAY VARY	PRODUCT DESCRIPTION <b>FIBER COUPLER, LC/LC QUAD, TRANSLUCENT INT. SHUTTER, SIDE SPRING, HIGH DENSITY, BLUE</b>			
	COLOR VARIATIONS MAY OCCUR	SIZE <b>A</b>	CAGE CODE <b>43321</b>	ITEM NO. <b>FOA-814-BLU</b>	REV. <b>A</b>
		SCALE: NONE	CAD FILE: FOA-814-BLU.SLDDRW		SHEET 1 OF 1