

THE INFORMATION CONTAINED IN THIS DRAWING IS THE SOLE PROPERTY OF L-COM, INC. ANY REPRODUCTION IN PART OR WHOLE WITHOUT THE WRITTEN PERMISSION OF L-COM, INC. IS PROHIBITED.

REVISIONS			
REV	DESCRIPTION	DATE	APPROVED
A	INITIAL RELEASE	2/18/22	PHOSPODAR

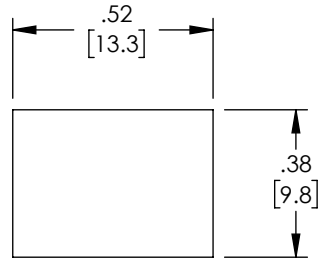

RECOMMENDED  
PANEL CUTOUT

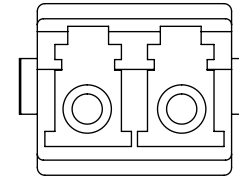
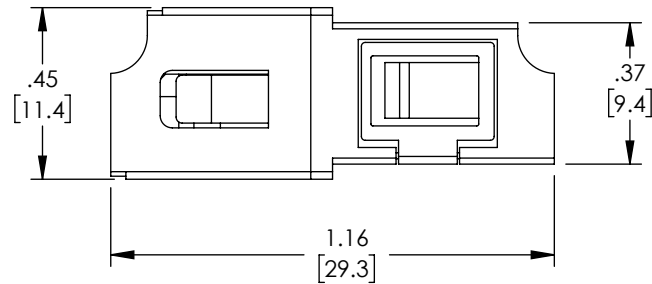
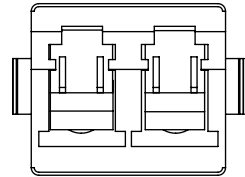
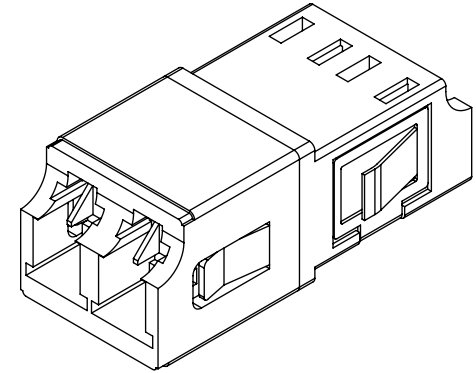
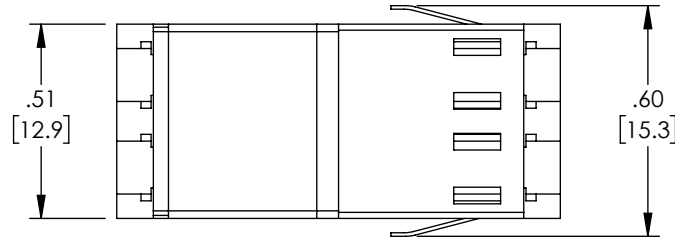

NOTES:

1. ALL DIMENSIONS ARE FOR REFERENCE ONLY.
2. DUST CAPS NOT SHOWN.
3. RECOMMENDED PANEL THICKNESS: .06" [1.5]
4. COMPONENT SHALL BE INDIVIDUALLY PACKAGED IN ACCORDANCE WITH L-COM SPECIFICATION PS-0031.

**REGULATORY COMPLIANCE:**

EU RoHS DIRECTIVE (MOST RECENT RELEASED VERSION)

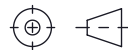
UNLESS OTHERWISE SPECIFIED, DIMENSIONS ARE IN INCHES [mm] OVERALL CABLE LENGTH TOLERANCE: ≤12 [305] = +1 [25] / -0 >12 [305] ≤60 [1524] = +2 [51] / -0 >60 [1524] ≤120 [3048] = +4 [102] / -0 >120 [3048] ≤300 [7620] = +6 [152] / -0 >300 [7620] = +5% / -0 ALL OTHER DIMENSIONAL TOLERANCES: .X = ± .2 [5]      FRACTIONS ± 1/32 .XX = ± .02 [5]      ANGLES ± 1° .XXX = ± .005 [1.3]	APPROVALS	DATE	 50 High Street, West Mill, North Andover, MA 01845 USA. Phone: 1.800.341.5266 1.978.682.6936
	DRAWN BY DMAY CHECKED BY BSTUSAK APPROVED BY PHOSPODAR	2/10/22 2/18/22 2/18/22	
THIRD-ANGLE PROJECTION 	CONFIGURATION DETAILS OF UNDIMENSIONED FEATURES MAY VARY COLOR VARIATIONS MAY OCCUR	PRODUCT DESCRIPTION <b>FIBER COUPLER, LC/LC DUPLEX, WHITE INTERNAL SHUTTER, SIDE SPRING, HIGH DENSITY, BEIGE</b>	SCALE: NONE    CAD FILE: FOA-811-BGE.SLDDRW    SHEET 1 OF 1
	SIZE <b>A</b>	CAGE CODE <b>43321</b>	ITEM NO. <b>FOA-811-BGE</b>