

THE INFORMATION CONTAINED IN THIS DRAWING IS THE SOLE PROPERTY OF L-COM, INC. ANY REPRODUCTION IN PART OR WHOLE WITHOUT THE WRITTEN PERMISSION OF L-COM, INC. IS PROHIBITED.

REVISIONS			
REV	DESCRIPTION	DATE	APPROVED
A	INITIAL RELEASE	08/12/2022	GUTTADAURO

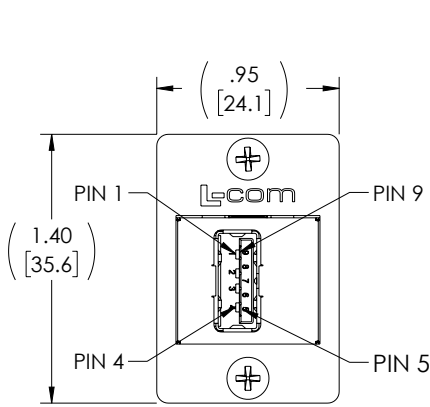

"J1"
USB 3.0 TYPE "A"
FEMALE CONNECTOR
30U" GOLD PLATED CONTACTS
NICKEL PLATED SHELL

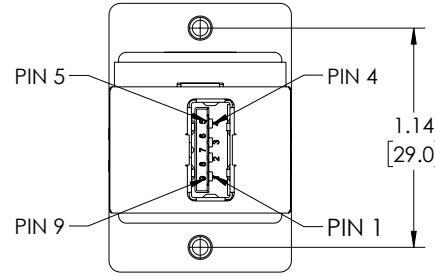
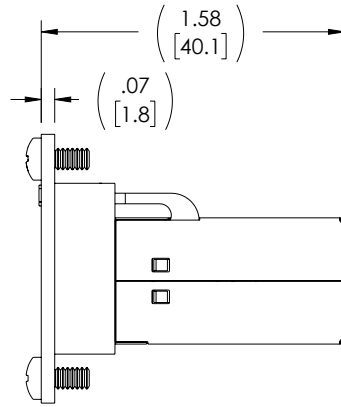

"J2"
USB 3.0 TYPE "A"
FEMALE CONNECTOR
30U" GOLD PLATED CONTACTS
NICKEL PLATED SHELL

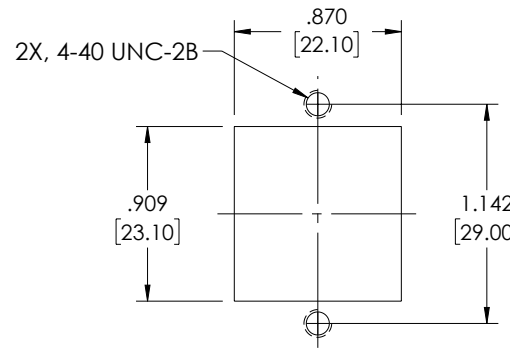
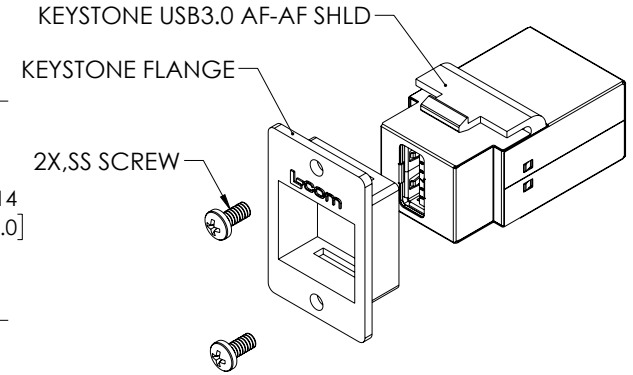

RECOMMENDED
PANEL CUTOUT

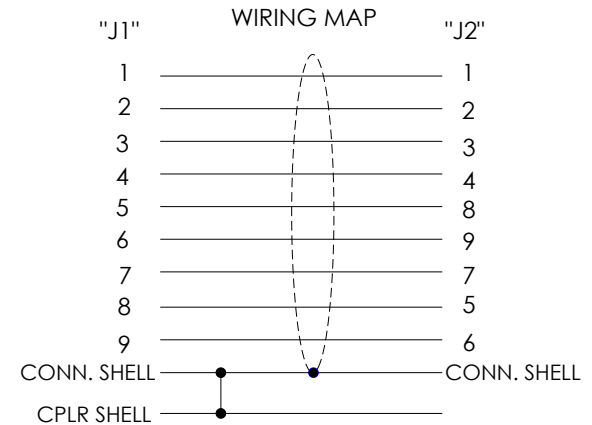

NOTES:

1. COUPLER HOUSING: ABS, UL94V-0 RATED, BLACK
COUPLER SHIELDING: STAINLESS STEEL
COUPLER PCB: GLASS FIBER EPOXY; FR-4, UL94 V-0
KEYSTONE FLANGE: ZINC ALLOY; NICKEL PLATED
2. KIT INCLUDES (KIT SHOWN FULLY ASSEMBLED FOR CLARITY):
1-KEYSTONE USB3.0 AF-AF SHIELDED
1-ZINC ALLOY KEYSTONE FLANGE
2-#4-40 UNC-2A x 1/4 LG STAINLESS STEEL SCREW
3. RATING:
CURRENT: 1.8A (P1 and P4 CONTACT); 0.25A (OTHER CONTACT)
OPERATING TEMPERATURE: -10°C TO +70°C.
4. COUPLER SHALL BE TESTED FOR CONTINUITY.
5. COUPLER KIT IS SHIPPED UN-ASSEMBLED AND SHALL BE PACKAGED IN ACCORDANCE WITH L-COM SPECIFICATION PS-0031.

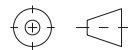
UNLESS OTHERWISE SPECIFIED, DIMENSIONS ARE IN INCHES [mm]	APPROVALS	DATE	 50 High Street, West Mill, North Andover, MA 01845 USA. Phone: 1.800.341.5266 1.978.682.6936
	OVERALL CABLE LENGTH TOLERANCE: ≤12 [305] = +1 [25] / -0 >12 [305] ≤60 [1524] = +2 [51] / -0 >60 [1524] ≤120 [3048] = +4 [102] / -0 >120 [3048] ≤300 [7620] = +6 [152] / -0 >300 [7620] = +5% / -0	DRAWN BY B.ZHANG 01/18/2022	
ALL OTHER DIMENSIONAL TOLERANCES: .X = ± .2 [5] FRACTIONS ± 1/32 .XX = ± .02 [.5] ANGLES ± 1° .XXX = ± .005 [.13]	APPROVED BY GUTTADAURO 01/18/2022	CONFIGURATION DETAILS OF UNDIMENSIONED FEATURES MAY VARY	CATEGORY USB
THIRD-ANGLE PROJECTION 	COLOR VARIATIONS MAY OCCUR	PRODUCT DESCRIPTION FLANGED PNL MNT CPLR KIT, USB3.0 AF-AF, SHLD	SIZE A
		CAGE CODE 43321	DWG. NO. ECFU3KEY-AA-S
		SCALE: NONE	CAD FILE: ECFU3KEY-AA-S.LDDRW
			SHEET 1 OF 1