

THE INFORMATION CONTAINED IN THIS DRAWING IS THE SOLE PROPERTY OF L-COM, INC. ANY REPRODUCTION IN PART OR WHOLE WITHOUT THE WRITTEN PERMISSION OF L-COM, INC. IS PROHIBITED.

REVISION					
ZONE	REV.	DESCRIPTION	DATE	CHANGED BY	APPROVED BY
	A	INITIAL RELEASE	08/03/2023	BPUCHASKI	DGUTTADAURO

D

D

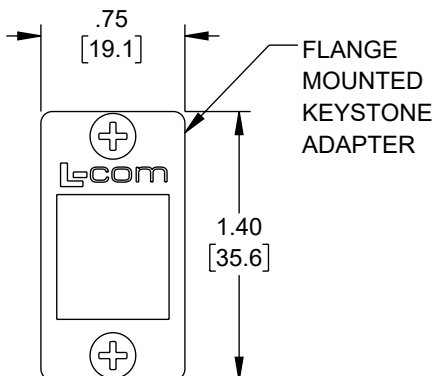
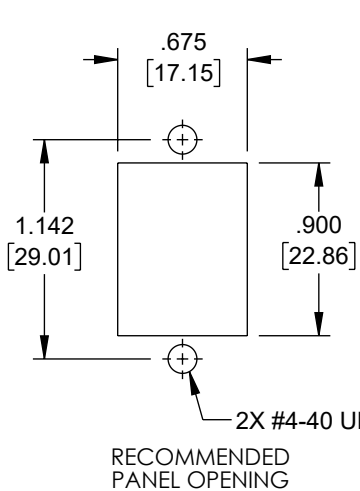

FLANGE MOUNTED KEYSTONE ADAPTER

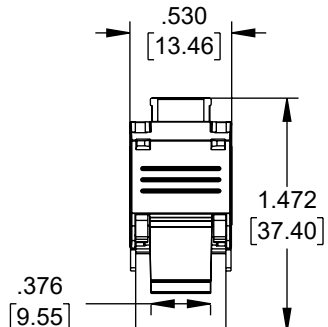

CAT 6A KEYSTONE ADAPTER (L-COM P/N: RJTLC6A28 WITHOUT PACKAGING)

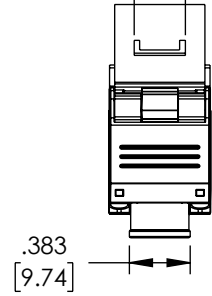
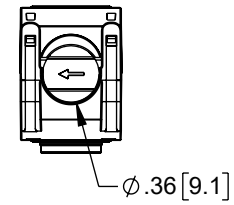
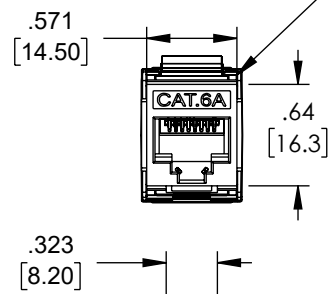
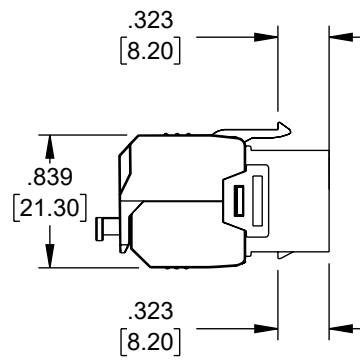

KIT INCLUDES:  
 1X ADAPTER  
 1X FLANGE ADAPTER  
 1X PACKAGE MOUNTING SCREWS (4-40 X 1/4")

NOTES:  
 MATERIAL:  
 FLANGED ADAPTER ZINC ALLOY  
 HARDWARE STAINLESS STEEL

FINISH:  
 FLANGE ADAPTER: NICKEL PLATE

MISCELLANEOUS:  
 DC CURRENT RATING: 1.5 AMPS

PACKAGING:  
 KIT SHAL BE INDIVIDUALLY PACKAGED IN ACCORDANCE WITH L-COM PACKAGING SPECIFICATION PS-0031

REGULATORY COMPLIANCE:  
 EU RoHS DIRECTIVE (MOST RECENT RELEASED VERSION)

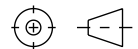
UNLESS OTHERWISE SPECIFIED, DIMENSIONS ARE IN INCHES [mm]	APPROVALS	DATE	 an INFINITI® brand	50 High Street, West Mill, North Andover, MA 01845 USA. Phone: 1.800.341.5266 1.978.682.6936		
	OVERALL CABLE LENGTH TOLERANCE: ≤12 [305] = +1 [25] / -0 >12 [305] ≤60 [1524] = +2 [51] / -0 >60 [1524] ≤120 [3048] = +4 [102] / -0 >120 [3048] ≤300 [7620] = +6 [152] / -0 >300 [7620] = +5% / -0	DRAWN BY BPUCHASKI			08/03/2023	
ALL OTHER DIMENSIONAL TOLERANCES: .X = ± .2 [5]   FRACTIONS ± 1/32 .XX = ± .02 [5]   ANGLES ± 1° .XXX = ± .005 [13]	CHECKED BY DFRISIELLO	08/03/2023	CATEGORY TELECOM / MODULAR			
	APPROVED BY GUTTADAURO	08/03/2023	PRODUCT DESCRIPTION Flange Kit, C6A Tool-less, 28AWG Slim, WHT			
THIRD-ANGLE PROJECTION 	CONFIGURATION DETAILS OF UNDIMENSIONED FEATURES MAY VARY	COLOR VARIATIONS MAY OCCUR	SIZE A	CAGE CODE 43321	ITEM NO. ECFRJTL6A28	REV. A
SCALE: NONE			CAD FILE: ECFRJTL6A28.SLDDRW		SHEET 1 OF 1	